

# **CATÁLOGO ELEMENTOS ADICIONALES**

## **ADDITIONAL ELEMENTS CATALOGUE**

[operaciones@easyfairs.com](mailto:operaciones@easyfairs.com)



**EMPACK**  
THE FUTURE OF PACKAGING

# ¡ATENCIÓN! ATTENTION!

HAY 4 PERIODOS DE PRECIOS:  
THERE ARE 4 PRICE PERIODS:

Del 10 de Mayo al 06 de Junio 2024  
From May 10 to Jun 06 2024

**EARLY BIRD**

Del 07 de Junio al 26 de Septiembre 2024  
From Jun 07 to September 26 2024

**REGULAR**

Del 27 de Septiembre al 7 de Noviembre 2024  
From September 27 to November 7 2024

**LATE**

Del 08 de Noviembre a celebración  
From November 08 to celebration

**ON-SITE**

Envía el Plano Técnico indicando  
dónde necesitáis cada elemento a  
[operaciones@easyfairs.com](mailto:operaciones@easyfairs.com)

*Send the Technical Plan to  
[operaciones@easyfairs.com](mailto:operaciones@easyfairs.com)  
indicating where you need each element*

\*\*Todas las imágenes son orientativas, el elemento puede cambiar en función del stock

\*\*All images are indicative, element may change depending on stock.

# ÍNDICE

## TABLE OF CONTENT



### **SERVICIOS EASYFAIRS | EASYFAIRS SERVICES**

---

SUELO | FLOOR

SERVICIOS | SERVICES

ELECTRICIDAD | ELECTRICAL SUPPLIES

ALMACENES | STORAGE ROOMS

MOBILIARIO | FURNITURE

COMPLEMENTOS | COMPLEMENTS

DECORACIÓN | DECORATION

### **SERVICIOS EXTERNOS | EXTERNAL SERVICES**

---

LOGÍSTICA DE CARGA, DESCARGA Y ALMACENAJE | *LOADING & UNLOADING LOGISTICS & STORAGE*

CATERING | *CATERING*

RIGGING | *RIGGING/TRUSS*

# SUELO FLOOR



Confirmar el color (siguiente pág.) a:  
[operaciones@easyfairs.com](mailto:operaciones@easyfairs.com)  
Confirm color (next page) to :  
[operaciones@easyfairs.com](mailto:operaciones@easyfairs.com)

CAMBIO DE COLOR DE MOQUETA/M<sup>2</sup>  
CHANGE COLOR CARPET/M<sup>2</sup>

EARLY BIRD: 4,72 €/M<sup>2</sup>  
REGULAR: 5,13 €/M<sup>2</sup>  
LATE: 7,18 €/M<sup>2</sup>  
ONSITE: 7,90 €/M<sup>2</sup>

MOQUETA/M<sup>2</sup> (STANDS SOLO SUELO)  
COLOR CARPET/M<sup>2</sup> (SPACE ONLY BOOTHS)

EARLY BIRD: 6,65 €/M<sup>2</sup>  
REGULAR: 7,23 €/M<sup>2</sup>  
LATE: 10,12 €/M<sup>2</sup>  
ONSITE: 11,13 €/M<sup>2</sup>

## SUELO TÉCNICO TECHNICAL FLOOR

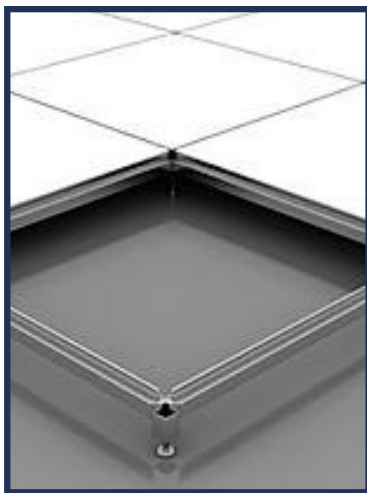

EARLY BIRD: 26,66 €/M<sup>2</sup>  
REGULAR: 28,98 €/M<sup>2</sup>  
LATE: 40,57 €/M<sup>2</sup>  
ONSITE: 44,63 €/M<sup>2</sup>

\*No incluye moqueta  
\*Carpet it is not included

## TARIMA MELAMINA BLANCA WOOD FLOOR



**BAJO PRESUPUESTO  
ON A BUDGET**

\*Correo a: [operaciones@easyfairs.com](mailto:operaciones@easyfairs.com)  
\*Email: [operaciones@easyfairs.com](mailto:operaciones@easyfairs.com)

# COLORES DE MOQUETA | CARPET COLOURS



Confirma el color de la moqueta a [operaciones@easyfairs.com](mailto:operaciones@easyfairs.com)  
Confirm carpet color to [operaciones@easyfairs.com](mailto:operaciones@easyfairs.com)

# SERVICIOS SERVICES

## AIRE COMPRIMIDO + CONEXIÓN COMPRESSED AIR + CONNECTOR



### Características:

- 1/2 Pulgada hembra.
- Presión hasta 6 kg/cm<sup>2</sup>.
- Diametro interno 10 mm.

### Characteristics:

- 1/2 inch female.
- Max. pression 6 kg/cm<sup>2</sup>.
- 10 mm int. diameter.

|             |            |
|-------------|------------|
| EARLY BIRD: | 849,04 €   |
| REGULAR:    | 922,87 €   |
| LATE:       | 1.292,01 € |
| ONSITE:     | 1.421,21 € |

## CONEXIÓN ADICIONAL ADDITIONAL CONNECTION



|             |          |
|-------------|----------|
| EARLY BIRD: | 128,80 € |
| REGULAR:    | 140 €    |
| LATE:       | 168 €    |
| ONSITE:     | 184,80 € |

## TOMA AGUA + CONEXIÓN WATER+ CONNECTION



### Características:

- 1/2 Pulgada hembra.
- Presión hasta 6 kg/cm<sup>2</sup>.
- Diametro interno 10 mm.

### Characteristics:

- 1/2 inch female.
- Max. pression 6 kg/cm<sup>2</sup>.
- 10 mm int. diameter.

|             |          |
|-------------|----------|
| EARLY BIRD: | 501,73 € |
| REGULAR:    | 557,48 € |
| LATE:       | 780,47 € |
| ONSITE:     | 858,52 € |

## CONEXIÓN ADICIONAL ADDITIONAL CONNECTION



|             |          |
|-------------|----------|
| EARLY BIRD: | 128,80 € |
| REGULAR:    | 140 €    |
| LATE:       | 168 €    |
| ONSITE:     | 184,80 € |

Para un uso óptimo del servicio, cada conexión incluye una toma y soporta una conexión adicional. En caso de necesitar más conexiones extras se deben contratar más tomas.

For optimal use of the service, each connection includes one inlet and supports one additional connection. If more connections are required, additional inlets must be ordered.

Envía el Plano Técnico indicando dónde necesitáis cada elemento  
*Send Technical Plan indicating where you need each element*

# ELECTRICIDAD ELECTRICITY

## ENCHUFES MONOFÁSICOS | SOCKETS

BASE DOBLE



BASE TRIPLE



MONOFÁSICA 3KW



3 PINES MONOFÁSICA



EARLY BIRD: 40,02 €  
REGULAR: 43,50 €  
LATE PRICE: 60,90 €  
ONSITE: 66,99 €

EARLY BIRD: 62,85 €  
REGULAR: 68,31 €  
LATE PRICE: 95,63 €  
ONSITE: 105,20 €

EARLY BIRD: 69,19 €  
REGULAR: 75,21 €  
LATE PRICE: 105,29 €  
ONSITE: 115,82 €

EARLY BIRD: 60,31 €  
REGULAR: 65,55 €  
LATE PRICE: 91,77 €  
ONSITE: 100,95 €

## CONEXIONES TRIFÁSICAS | THREEPHASE CONNECTIONS

| TOMA CETAC /<br>POWER SUPPLY  | EARLY BIRD | REGULAR  | LATE     | ONSITE   |
|---|------------|----------|----------|----------|
| <b>16A 3P+N+T</b><br><small>NECESITA CUADRO TRIFÁSICO DE 10 kw<br/>NEEDS THREEPHASE 10 kw BOX</small> | 91,08 €    | 99 €     | 138,60 € | 152,46 € |
| <b>32A 3P+N+T</b><br><small>NECESITA CUADRO TRIFÁSICO DE 20 kw<br/>NEEDS THREEPHASE 20 kw BOX</small> | 97,29 €    | 105,75 € | 148,05 € | 162,86 € |
| <b>32A 3P+T</b><br><small>NECESITA CUADRO TRIFÁSICO DE 20 kw<br/>NEEDS THREEPHASE 20 kw BOX</small>   | 113,16 €   | 123 €    | 172,20 € | 189,42 € |
| <b>63A 3P+N+T</b><br><small>NECESITA CUADRO TRIFÁSICO DE 30 kw<br/>NEEDS THREEPHASE 30 kw BOX</small> | 151,80 €   | 165 €    | 231 €    | 254,10 € |

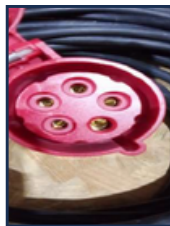

CONEXIONES MONOFÁSICAS SOLO PARA CUADROS MONOFÁSICOS  
MONOPHASE CONNECTIONS FOR MONOPHASE SWITCHBOARDS ONLY

CONEXIONES TRIFÁSICAS SOLO PARA CUADROS TRIFÁSICOS  
THREEPHASE CONNECTIONS FOR THREEPHASE SWITCHBOARDS ONLY

Envía el Plano Técnico indicando dónde necesitáis cada elemento  
*Send Technical Plan indicating where you need each element*

# CUADROS ELÉCTRICOS | ELECTRICAL BOXES

Será de obligatoria contratación el cuadro de corte con EASYFAIRS. Los KWS de consumo no están incluidos con la contratación del cuadro. El cuadro no incluye tomas.

It is mandatory to order the electrical box with EASYFAIRS. The KWS consumed are not included with the contracting of the box. Electrical plug are not included with the electrical box.



| CUADRO ELÉCTRICO / ELECTRICAL BOX | EARLY BIRD | REGULAR    | LATE       | ONSITE     |
|-----------------------------------|------------|------------|------------|------------|
| 3 KW - MONOFÁSICO                 | 52,08 €    | 56,61 €    | 79,25 €    | 87,18 €    |
| 5 KW - MONOFÁSICO                 | 114,02 €   | 123,93 €   | 173,50 €   | 190,85 €   |
| 10 KW - TRIFÁSICO                 | 269,56 €   | 293,00 €   | 410,19 €   | 451,21 €   |
| 15 KW - TRIFÁSICO                 | 423,69 €   | 460,53 €   | 644,74 €   | 709,22 €   |
| 20 KW - TRIFÁSICO                 | 577,12 €   | 627,30 €   | 878,22 €   | 966,04 €   |
| 30 KW - TRIFÁSICO                 | 885,38 €   | 962,37 €   | 1.347,32 € | 1.482,05 € |
| 40 KW - TRIFÁSICO                 | 1.196,46 € | 1.300,50 € | 1.820,70 € | 2.002,77 € |

## KW EXTRA



EARLY BIRD: 67,04 €/UD KW  
 REGULAR: 78,87 €/UD KW  
 LATE: 110,41 €/UD KW  
 ONSITE: 121,46 €/UD KW

Envía el Plano Técnico indicando dónde necesitáis cada elemento  
 Send Technical Plan indicating where you need each element



# PROTECTORES DIFERENCIALES | DIFFERENTIAL PROTECTORS

Será de obligatoria contratación el cuadro de corte con EASYFAIRS. Los KWS de consumo no están incluidos con la contratación del cuadro. El cuadro no incluye tomas.

It is mandatory to order the electrical box with EASYFAIRS. The consumption KWS are not included with the contracting of the box. Electrical plug are not included with the electrical box.

## PROTECTOR DIFERENCIAL 300 ma

### DIFFERENTIAL PROTECTOR 300 ma



|             |          |
|-------------|----------|
| EARLY BIRD: | 365,70 € |
| REGULAR:    | 397,50 € |
| LATE:       | 556,50 € |
| ONSITE:     | 612,15 € |

## PROTECTOR DIFERENCIAL SUPERINMUNIZADO 4 X63A TIPO A

### SUPERIMMUNISED DIFFERENTIAL PROTECTOR 4 X63A TYPE A



|             |          |
|-------------|----------|
| EARLY BIRD: | 507,15 € |
| REGULAR:    | 551,25 € |
| LATE:       | 771,75 € |
| ONSITE:     | 848,93 € |

## PROTECTOR DIFERENCIAL SUPERINMUNIZADO 4 X40A TIPO A

### SUPERIMMUNISED 4 X40A DIFFERENTIAL PROTECTOR TYPE A



|             |          |
|-------------|----------|
| EARLY BIRD: | 478,86 € |
| REGULAR :   | 520,50 € |
| LATE:       | 728,70 € |
| ONSITE:     | 801,57 € |

Envía el Plano Técnico indicando dónde necesitáis cada elemento  
*Send Technical Plan indicating where you need each element*

# ALMACENES STORAGE ROOM

100 X 100 X 250 CM

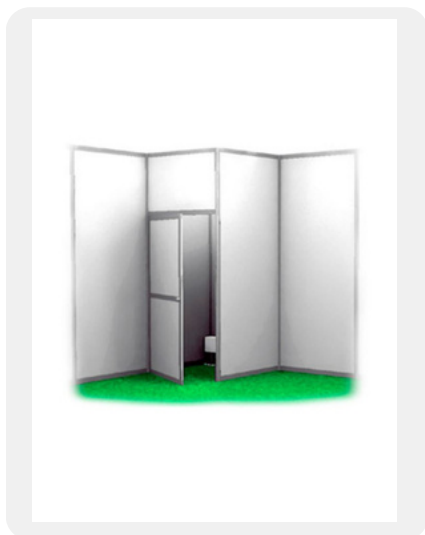

EARLY BIRD: 172,96 €  
REGULAR: 188 €  
LATE: 263,20 €  
ONSITE: 298,52 €

200 X 100 X 250 CM

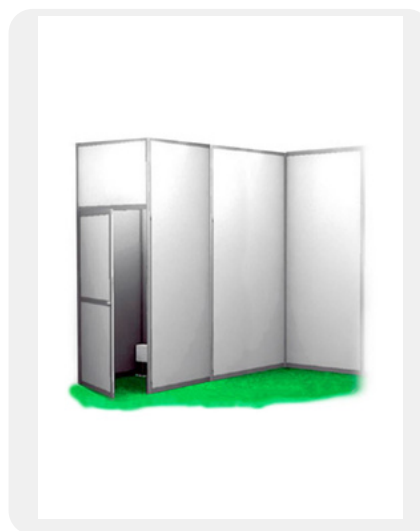

EARLY BIRD: 215,65 €  
REGULAR: 234,40 €  
LATE: 328,16 €  
ONSITE: 360,95 €

100X100X250CM + TOTEM  
+GRÁFICA EN TOTEM 2UDS

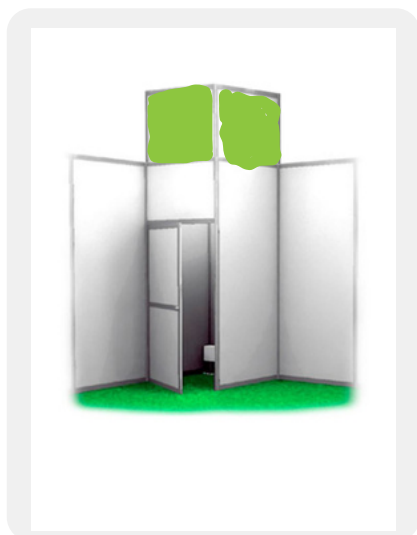

EARLY BIRD: 373,15 €  
REGULAR: 405,60 €  
LATE: 567,84 €  
ONSITE: 624,62 €

200X100X250 + TOTEM+GRÁFICA  
FRONTAL 2 M DE TOTEM

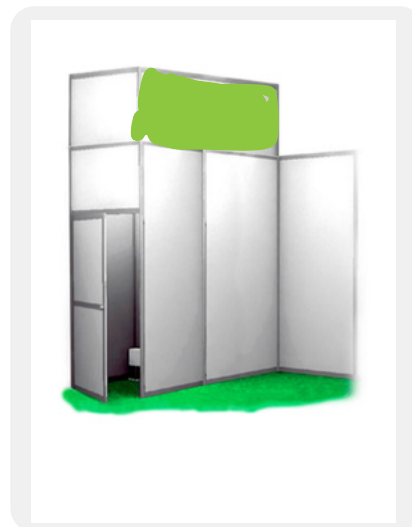

EARLY BIRD: 505,49 €  
REGULAR: 549,45 €  
LATE: 769,23 €  
ONSITE: 846,15 €

El totem se compone de 2 tableros: uno sobre el lateral del almacén y otro sobre la puerta.  
En caso de dejar el almacén visto a 3 caras habrá que adquirir el totem adicional.

The totem has 2 panels: one on the side of the storage room and one on the door.  
In case of having 3 visible sides storage room, an additional totem must be purchased.

Envía el Plano Técnico indicando dónde necesitáis cada elemento  
*Send Technical Plan indicating where you need each element*

# MOBILIARIO

## FURNITURE

**SILLA BLANCA O NEGRA**  
*CHAIR WHITE OR BLACK*



EARLY BIRD: 25,50 €  
REGULAR: 27,72 €  
LATE: 38,81 €  
ONSITE: 42,69 €

**TABURETE DISCO**  
*GINNY STOOL*



EARLY BIRD: 38,50 €  
REGULAR: 41,85 €  
LATE: 58,59 €  
ONSITE: 64,45 €

**MESA BAJA BLANCA O NEGRA**  
*WHITE OR BLACK LOW TABLE*



EARLY BIRD: 45,63 €  
REGULAR: 49,60 €  
LATE: 69,44 €  
ONSITE: 76,38 €

**MESA ALTA BLANCA O NEGRA**  
*WHITE OR BLACK HIGHTABLE*



EARLY BIRD: 50,78 €  
REGULAR: 55,20 €  
LATE: 77,28 €  
ONSITE: 85,01 €

**VITRINA VERTICAL  
SIN LUZ**

***VERTICAL DISPLAY CASE  
WITHOUT LIGHT***



EARLY BIRD: 145,45 €  
REGULAR: 158,10 €  
LATE: 221,34 €  
ONSITE: 243,47 €

**VITRINA  
CON LUZ**

***VERTICAL DISPLAY  
CASE WITH LIGHT***

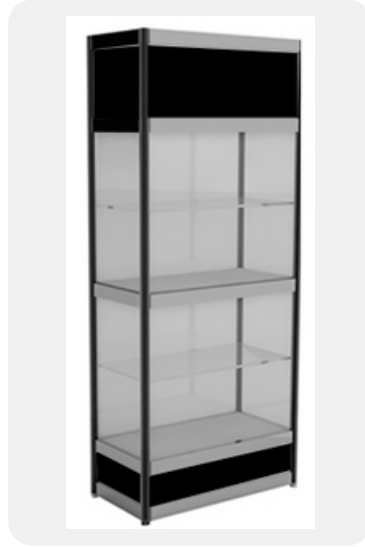

EARLY BIRD: 231,01 €  
REGULAR: 251,10 €  
LATE: 351,54 €  
ONSITE: 389,69 €

**ESTANTERÍA  
METÁLICA**

***METAL SHELF***



EARLY BIRD: 68,26 €  
REGULAR: 74,20 €  
LATE: 103,88 €  
ONSITE: 114,27 €

**MOSTRADOR LEVANTE  
*LEVANTE COUNTER***



EARLY BIRD: 184,09 €  
REGULAR: 200,10 €  
LATE: 280,14 €  
ONSITE: 308,15 €

**ESTANTE RECTO  
*SHELF WHITE***



EARLY BIRD: 31,74 €  
REGULAR: 34,50 €  
LATE: 48,30 €  
ONSITE: 53,15 €

**MOSTRADOR MODULAR SIN  
PUERTAS**  
*COUNTER WITHOUT DOORS*



EARLY BIRD: 71,10 €  
REGULAR: 77,28 €  
LATE: 108,19 €  
ONSITE: 119,01 €

**MOSTRADOR MODULAR CON  
PUERTAS**  
*COUNTER WITH DOORS*



EARLY BIRD: 88,76 €  
REGULAR: 96,48 €  
LATE: 135,07 €  
ONSITE: 148,58 €

**ARMARIO BAJO CON PUERTAS**  
*LOW CABINET*



EARLY BIRD: 79,21 €  
REGULAR: 86,16 €  
LATE: 120,54 €  
ONSITE: 132,59 €

**MOSTRADOR VITRINA**  
*SHOWCASE COUNTER*



EARLY BIRD: 100,30 €  
REGULAR: 109,02 €  
LATE: 152,63 €  
ONSITE: 167,89 €

# COMPLEMENTOS COMPLEMENTS

## PODIUM | PODIUM

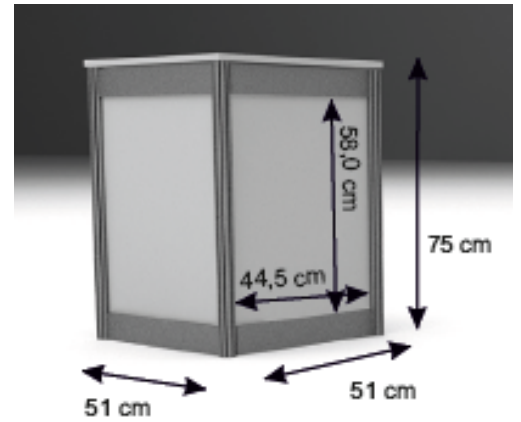
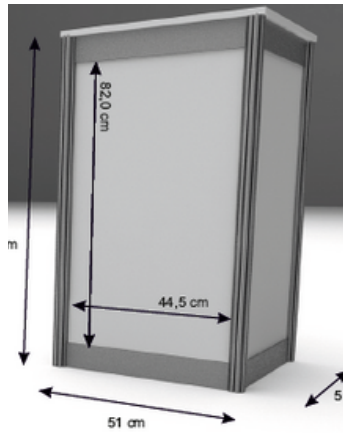
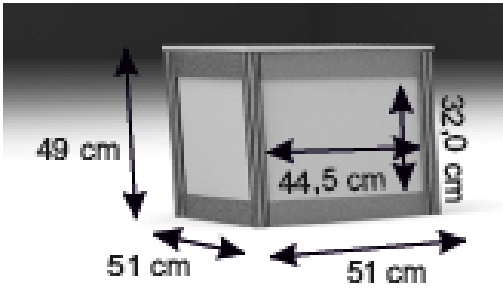

| PODIUM             | EARLY BIRD | REGULAR | LATE    | ONSITE  |
|--------------------|------------|---------|---------|---------|
| 100 CM ALTO / HIGH | 53,36 €    | 58 €    | 81,20 € | 89,32 € |
| 75 CM ALTO / HIGH  | 49,36 €    | 53,65 € | 75,11 € | 82,62 € |
| 50 CM ALTO / HIGH  | 46,69 €    | 50,75 € | 71,05 € | 78,16 € |

## PORTAFOLLETOS *BROCHURE*



EARLY BIRD: 62,60 €  
REGULAR: 68,04 €  
LATE: 95,26 €  
ONSITE: 104,78 €

## PERCHERO DE PIE *RACK*



EARLY BIRD: 45,46 €  
REGULAR: 49,41 €  
LATE: 69,17 €  
ONSITE: 76,09 €

## PAPELERA *BIN*



EARLY BIRD: 5,52 €  
REGULAR: 6,00 €  
LATE: 8,40 €  
ONSITE: 8,24 €

**MINI FRIGORIFICO**  
*MINI FRIDGE*



EARLY BIRD: 89,70 €  
REGULAR: 97,50 €  
LATE: 136,50 €  
ONSITE: 150,15 €

**PANTALLA PLASMA**  
*TV*



EARLY BIRD: 345.98 €  
REGULAR: 376,06 €  
LATE: 518,97 €  
ONSITE: 570,86 €



EARLY BIRD: 392,23 €  
REGULAR: 426,34 €  
LATE: 588,35 €  
ONSITE: 647,18 €

**WIFI**



| WIFI                | EARLY BIRD | REGULAR  | LATE     | ONSITE     |
|---------------------|------------|----------|----------|------------|
| WI-FI 1 USER/EVENT  | 145,98 €   | 158,68 € | 222,15 € | 244,36 €   |
| WI-FI 3 USERS/EVENT | 405,49 €   | 440,75 € | 617,05 € | 678,75 €   |
| WI-FI 5 USERS/EVENT | 616,35 €   | 669,94 € | 937,92 € | 1.031,71 € |

**INTERNET**



| CABLE       | EARLY BIRD | REGULAR    | LATE       | ONSITE     |
|-------------|------------|------------|------------|------------|
| 10 MB/EVENT | 567,68 €   | 617,05 €   | 863,87 €   | 950,25 €   |
| 20 MB/EVENT | 908,29 €   | 987,28 €   | 1.382,19 € | 1.520,40 € |
| 30 MB/EVENT | 1.524,63 € | 1.657,21 € | 2.320,10 € | 2.552,11 € |



# DECORACIÓN

## DECORATION

### PANEL DE VINILO VYNIL PANEL



EARLY BIRD: 115,75 €  
REGULAR: 125,82 €  
LATE: 176,15 €  
ONSITE: 193,76 €

Precio por panel - Cost per pannel

### PANEL DE FOAM FOAM PANEL



EARLY BIRD 188,97 €  
REGULAR: 205,40 €  
LATE: 287,56 €  
ONSITE: 316,32 €

Precio por panel - Cost per pannel

### VINILO EN FRONTAL MOSTRADOR FRONT BRANDED COUNTER



EARLY BIRD: 56,30 €  
REGULAR : 61,20 €  
LATE PRICE: 85,68 €  
ONSITE: 94,25 €



# ESPECIFICACIONES TÉCNICAS DE ARTES FINALES

## TECHNICAL SPECIFICATION FOR FINAL ARTS

El archivo debe enviarse por email a [operaciones@easyfairs.com](mailto:operaciones@easyfairs.com) o por [Wetransfer](#) en PDF siendo el nombre del archivo:

- Feria + N° de stand + posición en el stand
  - Ejemplo 1: EMPACK\_6G20\_VINILO PANEL 1 empezando por la izquierda.pdf
  - Ejemplo 2: LOGISTICS\_6A03\_MOSTRADOR CON PUERTA FRONTAL.pdf
  - Ejemplo 3: LIB\_6D30\_TOTEM LATERAL DERECHO



### A TENER EN CUENTA:

- No se debe dar sangre a ningún documento, el tamaño debe ser el exacto par ala impresión, tamaño de archivo= tamaño de impresión.
- Se debe trabajar en un **programa de diseño**. Y al exportar los archivos en PDF debes:
  - Archivos siempre al 10% o al 100%
  - Espacio de color CMYK
  - Resolución óptima de imágenes vinculadas: 100ppp.a escala 100%
  - Formato PDF 1.4 (mínimo). Sin canales, capas, etc
- Importante:
  - **INCRUSTAR IMÁGENES Y TEXTOS**, en su defecto enviarnos una carpeta con las imágenes y las fuentes utilizadas.
  - Siempre enviar los artes finales con los **textos trazados**
  - Todas las líneas gráficas o iconos dibujados a **líneas deben estar convertidos en contorno**.
  - **Líneas de troquel**: crea la línea de torquel deaseada, selecciona como color de contorno **una tinta plana** y nómbrala como "cut".
  - Recuerde **revisar bien los documentos** antes de enviarlos a producir, ortografía, resolución correcta de las imágenes, colores... una vez impreso si se quiere cambiar el diseño se cobrará otra vez el importe.



The file must be sent by email to [operaciones@easyfairs.com](mailto:operaciones@easyfairs.com) or by [Wetransfer](#) as a PDF file name:

- Trade fair + stand no. + stand position
  - Example 1: EMPACK\_6G20\_VINYL PANEL 1 starting from left.pdf
  - Example 2: LOGISTICS\_6A03\_FRONT DOOR DISPLAY.pdf
  - Example 3: LIB\_6D30\_RIGHT SIDE STAND\_TOTEM



### TO NOTE:

- No document should be given blood, the size should be the exact size for printing, file size = print size.
- You must work in a **design programme**. And when exporting PDF files you should:
  - Files always at 10% or 100%.
  - CMYK colour space
  - Optimal resolution of linked images: 100 dpi at 100% scale.
  - PDF 1.4 format (minimum). No channels, layers, etc.
- Important:
  - **INCORPORATE IMAGES AND TEXTS**, otherwise send us a folder with the images and fonts used.
  - Always send the final artwork with the drawn texts.
  - All graphic lines or icons drawn to lines must be converted to outlines.
  - Die-cut lines: create the die-cut line, select a spot colour as the outline colour and name it "cut".
  - Remember to check the documents well before sending them to production, spelling, correct resolution of the images, colours... once printed, if you want to change the design, you will be charged again.



# MEDIDAS PARA ARTES FINALES

## MEASURES FOR FINAL ARTS

| CONCEPTO<br>CONCEPT  | MEDIDA GRÁFICA<br>GRAPHIC MEASUREMENTS  |
|--|---|
| PODIUM   | 100 CM - 44,5 cm x 82 cm<br>75 CM - 44,5 cm x 58 cm<br>50 CM - 44,5 cm x 32 cm  |
| MOSTRADOR MODULAR<br>COUNTER   | FRONTAL 95cm x 82 cm<br>LATERAL 45cm x 82 cm                                    |
| MOSTRADOR VITRINA<br>SHOWCASE COUNTER  | FRONTAL 100 cm x 60 cm<br>LATERAL 50 cm x 60 cm                                 |
| TOTEM  | 1 X 1 - 96 cm x 86 cm<br>2 X 1 - 196 cm x 86 cm                                 |
| UD PANEL PARA VINILO<br>U. VYNIL PANEL                                       | 95 cm x 233 cm  |
| UD PANEL PARA FOAM<br>U. FOAM PANEL  | 1 m x 2,5 m   |
| PUERTA ALMACÉN<br>STORAGE ROOM DOOR  | SUPERIOR 95 cm x 27 cm<br>MEDIO 91,1 cm x 76,4 cm<br>INFERIOR 91,1 cm x 76,4 cm |
| COSTILLAS LATERALES Y<br>ESTRUCTURALES<br>LATERAL AND STRUCTURAL<br>SUPPORTS | VINILO 25 cm x 233 cm<br>FOAM 30 cm x 250 cm                                    |

\*Puedes encontrar imágenes de tipos de stand [AQUÍ](#), cualquier duda contacta con [operaciones@easyfairs.com](mailto:operaciones@easyfairs.com) para solicitar más información.

\*You can find images of stand types [HERE](#), if you have any questions please contact [operaciones@easyfairs.com](mailto:operaciones@easyfairs.com) for more information.

# OTROS SERVICIOS OTHERS SERVICES

## SERVICIOS EXTERNOS | EXTERNAL SERVICES

---

LOGÍSTICA DE CARGA, DESCARGA Y ALMACENAJE | LOADING & UNLOADING, LOGISTICS & STORAGE (DB SCHENKER):

[ifema.madrid@dbschenker.com](mailto:ifema.madrid@dbschenker.com)

CATERING | CATERING: [antara.madrid@areas.com](mailto:antara.madrid@areas.com)

RIGGING | RIGGING/TRUSS: [inspeccion.rigging@ifema.es](mailto:inspeccion.rigging@ifema.es);  
[stecnica@ifema.es](mailto:stecnica@ifema.es)

**Para cualquier duda o propuesta, envíe un email a  
[operaciones@easyfairs.com](mailto:operaciones@easyfairs.com)**

*Send an email to [operaciones@easyfairs.com](mailto:operaciones@easyfairs.com) if you have any  
doubt or comment*

**¡MUCHAS GRACIAS!**  
**MANY THANKS!**

